

DIGITAL CAMERA

ORCA[®]-Flash4.0

Changing the Game

Hamamatsu's brilliantly designed ORCA-Flash4.0 is truly a game changer in the world of scientific imaging. Built on a revolutionary new Gen II sCMOS detector, the ORCA-Flash4.0 is the first sCMOS camera that challenges the performance of all CCD, EM-CCD, and Gen I sCMOS cameras. With its combination of low noise and high quantum efficiency, the ORCA-Flash4.0 delivers unprecedented sensitivity as well as high dynamic range, blazing fast speeds, large field of view, and excellent resolution—all at once. The new standard for sensitivity, speed, and resolution is here. We think you will enjoy the results.

Exceptional sensitivity

Over 70 % at 600 nm

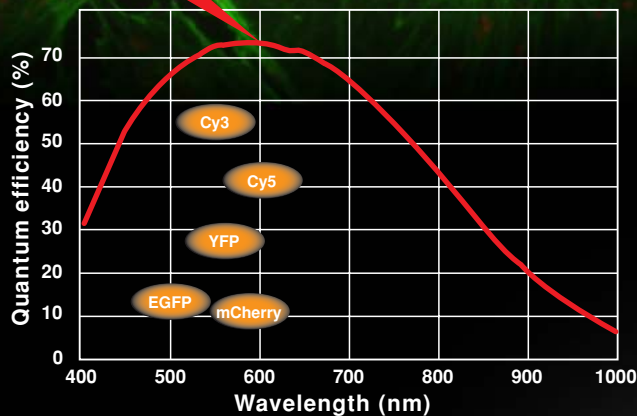

Low noise

1.3 electrons
at 100 frames/s

High-speed readout

100 frames/s
at full resolution

High resolution

4.0 megapixels
at 6.5 μm \times 6.5 μm pixels



HAMAMATSU
PHOTON IS OUR BUSINESS

High sensitivity means extreme versatility

Cooled CCDs have been the go-to technology for fluorescence applications such as GFP or multi-channel imaging that require high contrast, high signal-to-noise images. **The ORCA-Flash4.0 is changing the game.**

And until now, scientists have used EM-CCDs for low-light, often high-speed imaging such as TIRF or spinning disk confocal. For lack of a better choice, the same technology has also been adopted for localization microscopy. **Move over EM-CCD: the ORCA-Flash4.0 is changing this game, too.**

The performance of the ORCA-Flash4.0 camera offers such a multitude of benefits that it not only easily accomplishes each of these applications—it does them better.

Quantum efficiency: higher than 70 % at 600 nm and 50 % at 750 nm

The ORCA-Flash4.0 is engineered to outperform all other cameras for fluorescence microscopy. With carefully designed pixels and on-chip lens technology, its Gen II sCMOS sensor provides high QE across the range of wavelengths most commonly used in fluorescence microscopy.

Low noise: 1.3 electrons

The ORCA-Flash4.0 has the lowest read noise at 100 frames/s of any CCD or sCMOS camera. Even EM-CCDs trade off “relative” low read noise for multiplicative noise by using on-chip gain. But the ORCA-Flash4.0 requires no tradeoffs. Our “quiet” electronics successfully lower the limit of detection, allowing you to take full advantage of high frame rates and see your signal with fewer photons.

The unique combination of high quantum efficiency and low noise, in the absence of EM-CCD multiplicative noise, means that your images are not limited by the camera. Detect signal at low light levels, compare small changes in intensity, and discriminate small signals amid large backgrounds—with ease. **It's easy to see why the ORCA-Flash4.0 is changing the game.**

For detailed information on the effects of multiplicative noise in EM-CCDs compared to Gen II sCMOS sensors please review our white paper “ORCA-Flash4.0: Changing the Game” at <http://hamamatsucameras.com>

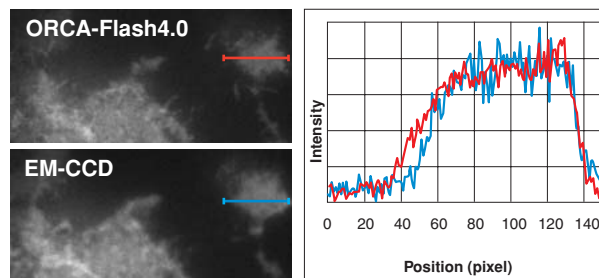

For the same number of input photons the ORCA-Flash4.0 delivers consistently higher signal-to-noise ratios compared to EM-CCDs. The large intensity variation apparent in the data from the EM-CCD is a direct result of multiplicative noise.

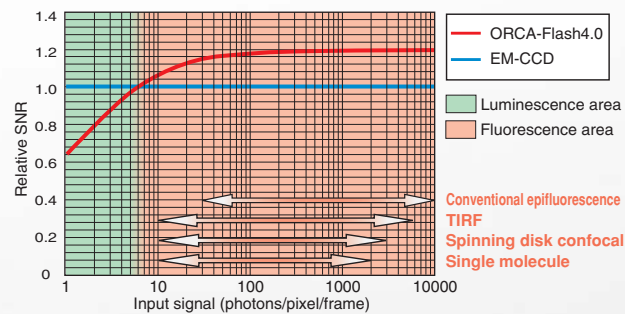
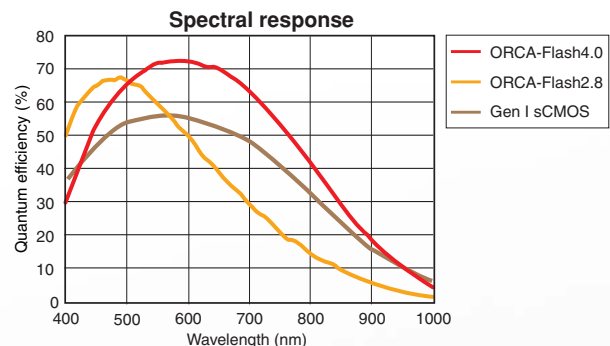

At just 5 photons per pixel, the ORCA-Flash4.0 exceeds the signal-to-noise performance of an EM-CCD camera.

Wide field of view & high resolution

With 4.0 megapixels at $6.5 \mu\text{m} \times 6.5 \mu\text{m}$ each, the ORCA-Flash4.0 is the ideal format for demanding microscopy applications. Whether imaging at high magnification, requiring finely detailed images of an individual cell, or low magnification, aiming to capture and resolve images of many cells, the ORCA-Flash4.0 delivers beautiful images.

Comparison of field of view

Field of view is 2.5× larger than that of a standard EM-CCD camera.

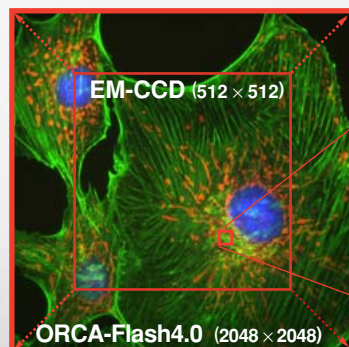

Comparison of resolution

The $6.5 \mu\text{m} \times 6.5 \mu\text{m}$ pixels of the ORCA-Flash4.0 enable much finer detail to be resolved when compared to the $16 \mu\text{m} \times 16 \mu\text{m}$ pixels of an EM-CCD camera.

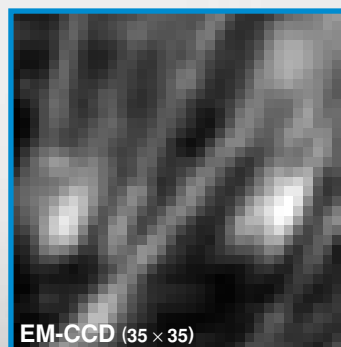
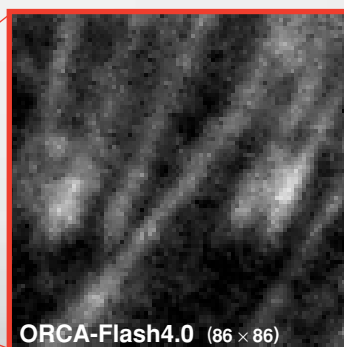

▲ Sample: FluoCells Prepared Slide #1, Object lens: S Plan Fluor 100×

High speed

Up to 15 min. of continuous full speed, full resolution acquisition*

4.0 megapixels, one hundred times per second—that is serious pixel throughput! Building on our experience with high-speed scanning cameras, Hamamatsu engineers designed the ORCA-Flash4.0 with dual CameraLink cables connected to a single, state of the art CameraLink board. When combined with a recommended solid state hard drive and high-speed computer, this configuration keeps your full resolution data flowing. For those experiments that need the most temporal resolution, the ORCA-Flash4.0 features flexible region of interest to dial up your speed—up to 25 600 frames/s.

Low noise and fast readout time simultaneously

| Readout method | Number of pixels | Readout speed at center position (frames/s) |
|--------------------------------------|------------------|---|
| Full resolution | 2048 × 2048 | 100 |
| Sub-array readout (typical examples) | 2048 × 1024 | 200 |
| | 2048 × 512 | 400 |
| | 2048 × 256 | 800 |
| | 2048 × 64 | 3200 |
| | 2048 × 8 | 25 600 |

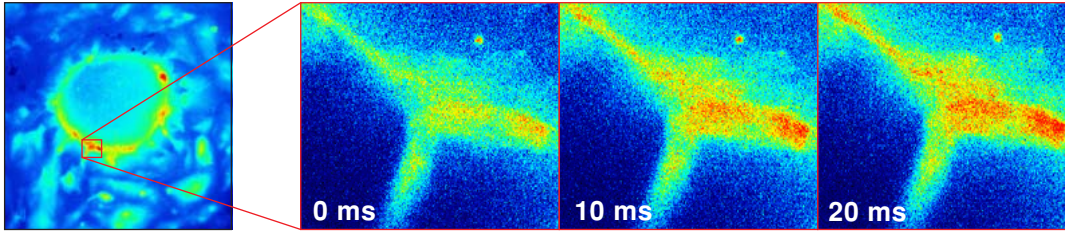

▲ High-speed Ca^{2+} imaging of cardiomyocyte derived from human iPS cell stained with Fluo8-AM. Sequential images were obtained every 10 ms. Left: whole FOV of the ORCA-Flash4.0 image. Right: magnified images show rapid and finely localized changes in intracellular Ca^{2+} concentration associated with cardiomyocyte contractions.

Behind-the-scene quality & innovations

The ORCA-Flash4.0 is a solid piece of camera engineering. Our small package bundles many years of Hamamatsu experience with an array of important and innovative performance enhancements.

Performance optimized cooling

For 25 years, Hamamatsu has been an industry leader in the cooling of scientific cameras. The ORCA-Flash4.0 is no exception. Air-cooled to $-10\text{ }^{\circ}\text{C}$, the ORCA-Flash4.0 finds the balance between meeting performance needs versus satisfying sleek marketing specs.

Outstanding image uniformity

At all input light levels the ORCA-Flash4.0 shows exceptional image uniformity across the entire sensor as compared to cameras based on Gen I sCMOS technology.

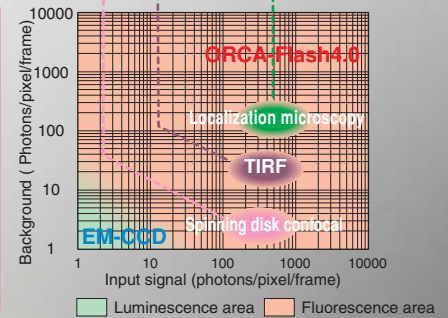
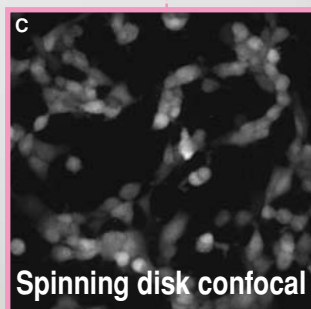
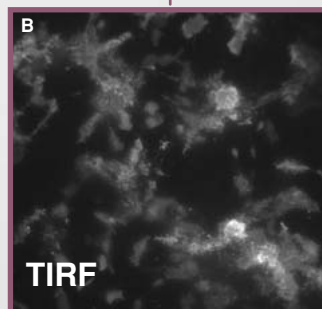
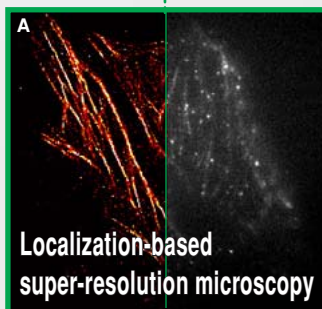
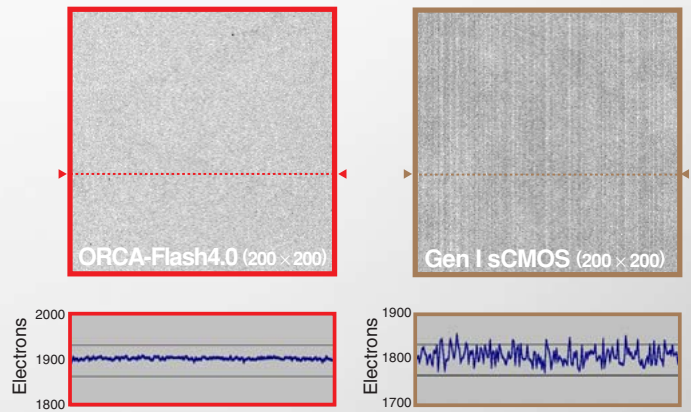

- A HeLa cells labeled with d2EosFP. Left: reconstructed image. Right: single TIRF image from data used for reconstruction. (Images courtesy of Prof. Zhen-li Huang, Britton Chance Center for Biomedical Photonics, Wuhan National Laboratory for Optoelectronics, Huazhong University of Science and Technology.)
- B Ins-1 cell MARCS-DsRed (Image courtesy of Dr. Hideo Mogami, Hamamatsu University.)
- C HEK293 cells stained with Fluo8-AM, Yokogawa CSU Spinning Disk Confocal



Specifications

| Product number | C11440-22C (ORCA-Flash4.0) | |
|---------------------------------------|--|------------------------|
| Imaging device | Scientific CMOS sensor FL-400 | |
| Effective number of pixels | 2048(H) × 2048(V) | |
| Cell size | 6.5 μm × 6.5 μm | |
| Effective area | 13.312 mm × 13.312 mm | |
| Full well capacity (typ.) | 30 000 electrons | |
| Readout noise (at 100 frames/s, typ.) | 1.3 electrons | |
| Dynamic range (typ.) | 23 000:1 | |
| Quantum efficiency | Higher than 70 % at 600 nm and 50 % at 750 nm | |
| Cooling method | Sensor temp. | Dark current (typ.) |
| Forced air (Ambient at +20 °C) | -10 °C | 0.5 electrons/pixel/s |
| Water (+20 °C) | -20 °C | 0.15 electrons/pixel/s |
| Water (+15 °C) | -30 °C | 0.05 electrons/pixel/s |
| Frame rate | | |
| Full resolution | 100 frames/s | |
| 1024 lines at center position | 200 frames/s | |
| 8 lines at center position | 25 655 frames/s | |
| A/D conversion | 16 bit output | |
| Readout modes | Digital binning 2 × 2 / 4 × 4 Sub-array readout mode | |
| Exposure time | 9.7 μs to 10 s | |
| Digital interface | CameraLink full configuration Deca mode | |
| Lens mount | C-mount | |
| Power requirement | AC 100 V to AC 240 V, 50 Hz/60 Hz | |
| Power consumption | Approx. 90 VA | |
| Trigger in | | |
| External trigger mode | Edge, Level, Synchronous readout and Start trigger | |
| External trigger signal routing | SMA connector or CameraLink I/F | |
| External trigger delay function | 0 to 10 s in 10 μs steps | |
| Trigger out | | |
| External signal output | 3 programmable timing outputs Global exposure timing and Trigger ready output | |
| External signal output routing | SMA connector | |
| Software | | |
| Software interface | PC-based acquisition package included DCAM-SDK, commercially available software | |

Dimensional outlines

- Camera head (approx. 2.0 kg)
- Unit: mm

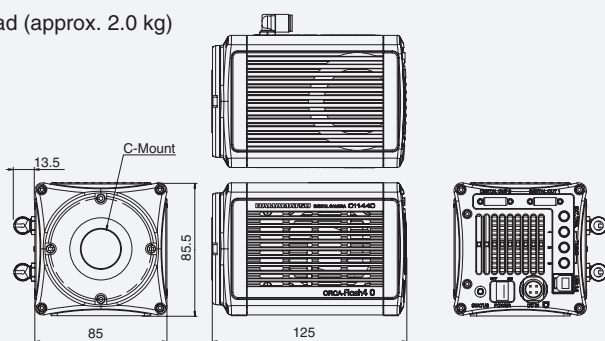

System configuration

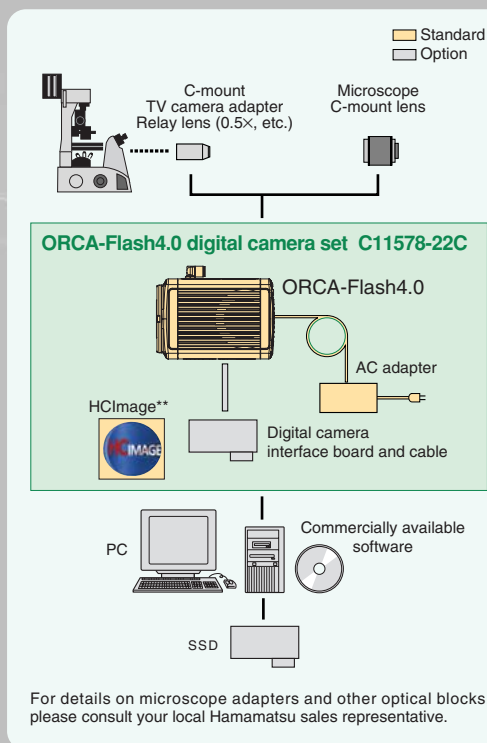

Applications

The ORCA-Flash4.0 is ideally suited for fluorescence and other widefield microscopy applications.

- Super resolution microscopy
- TIRF microscopy
- Live cell GFP
- Time lapse fluorescence
- Ratio imaging
- FRET
- High-speed Ca²⁺ imaging
- Real-time confocal microscopy
- Light sheet microscopy
- Morphology
- Fluorescence in situ hybridization (FISH)

* This was tested with Dell T7500 + SSD OCZ RVD3X2-FHPX4-480G x 2 pcs + Software RAID 0 configurations. (as of Nov. 2011).
**HClmage software provides standard image measurements functions. Upgrades to more feature-rich versions are available.

ORCA is registered trademark of Hamamatsu Photonics K.K. (France, Germany, Japan, U.K., U.S.A.)

HClmage is registered trademark of Hamamatsu Photonics K.K. (Australia, China, EU, Japan, Norway, Singapore, Switzerland, U.S.A.)

Product and software package names noted in this documentation are trademarks or registered trademarks of their respective manufacturers.

- Subject to local technical requirements and regulations, availability of products included in this promotional material may vary. Please consult your local sales representative.
- Information furnished by HAMAMATSU is believed to be reliable. However, no responsibility is assumed for possible inaccuracies or omissions. Specifications and external appearance are subject to change without notice.

© 2011 Hamamatsu Photonics K.K.

HAMAMATSU

Homepage Address <http://www.hamamatsu.com>

HAMAMATSU PHOTONICS K.K., Systems Division

812 Joko-cho, Higashi-ku, Hamamatsu City, 431-3196, Japan, Telephone: (81)53-431-0124, Fax: (81)53-435-1574, E-mail: export@sys.hpk.co.jp

U.S.A. and Canada: Hamamatsu Corporation: 360 Foothill Road, Bridgewater, N.J. 08807-0910, U.S.A., Telephone: (1)908-231-0960, Fax: (1)908-231-0852, E-mail: usa@hamamatsu.com

Germany: Hamamatsu Photonics Deutschland GmbH: Arzbergerstr. 10, D-82211 Herrsching am Ammersee, Germany, Telephone: (49)8152-375-0, Fax: (49)8152-2658, E-mail: info@hamamatsu.de

France: Hamamatsu Photonics France S.A.R.L.: 19, Rue du Saule Trapu, Parc du Moulin de Massy, 91882 Massy Cedex, France, Telephone: (33)1 69 53 71 00, Fax: (33)1 69 53 71 10, E-mail: infos@hamamatsu.fr

United Kingdom: Hamamatsu Photonics UK Limited: 2 Howard Court, 10 Tewin Road, Welwyn Garden City, Hertfordshire, AL7 1BW, U.K., Telephone: (44) 1707-294888, Fax: (44) 1707-325777, E-mail: info@hamamatsu.co.uk

North Europe: Hamamatsu Photonics Norden AB: Smidsvågen 12, SE-171-41 Solna, Sweden, Telephone: (46)8-509-031-00, Fax: (46)8-509-031-01, E-mail: info@hamamatsu.se

Italy: Hamamatsu Photonics Italia S.R.L.: Strada della Moia, 1 int.6-20020 Arese (Milano), Italy, Telephone: (39)02-935 81 733, Fax: (39)02-935 81 741, E-mail: info@hamamatsu.it

Cat. No. SCAS0081E01
NOV/2011 HPK
Created in Japan